



ATOM

Cloud-connected high performance multimedia elevator display

Installation Guide



Before you start

Items Required for Installation:

- + ATOM Multimedia Display
- + Display Lens
- + Power Supply
- + 8 x M4 Fixing Screws

Tools Required for Installation: (Not Included)+

- + Screwdriver
- + Power Drill suitable for 4.5mm Holes
- + Digital Multimeter

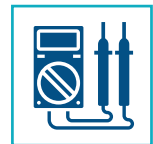
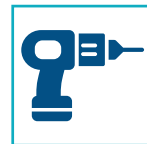

Optional Items Dependent on Installation:

- + VDSL Converters (x2 per lift) for remote layout updates
- + 24VDC Power Supply (135-0-1-0022)
- + Encoder CX-BASIC (for lift signals)
- + CX-Synchro (time synchronisation)
- + Router (for connection to building network)
- + Ethernet Switch (for multi-lift building connection)
- + 5m USB Extension Cable Male/Female (133-C-1-0229)

www.dewhurst.co.uk
displays@dewhurst-global.com



We operate a policy of continuous product development and reserve the right to change or improve specification without prior notice. E & OE.

All information within this document is for guidance only and does not form the basis for contract. The product images and diagrams shown are for illustration purposes only and may not be an exact representation of the latest version of the product. ©2023 Dewhurst. All Rights Reserved.

Please consider the environment before you print this document.



Access the Dewhurst
ATOM webpage for
more information



1. Wiring Connections & Switches – ATOM

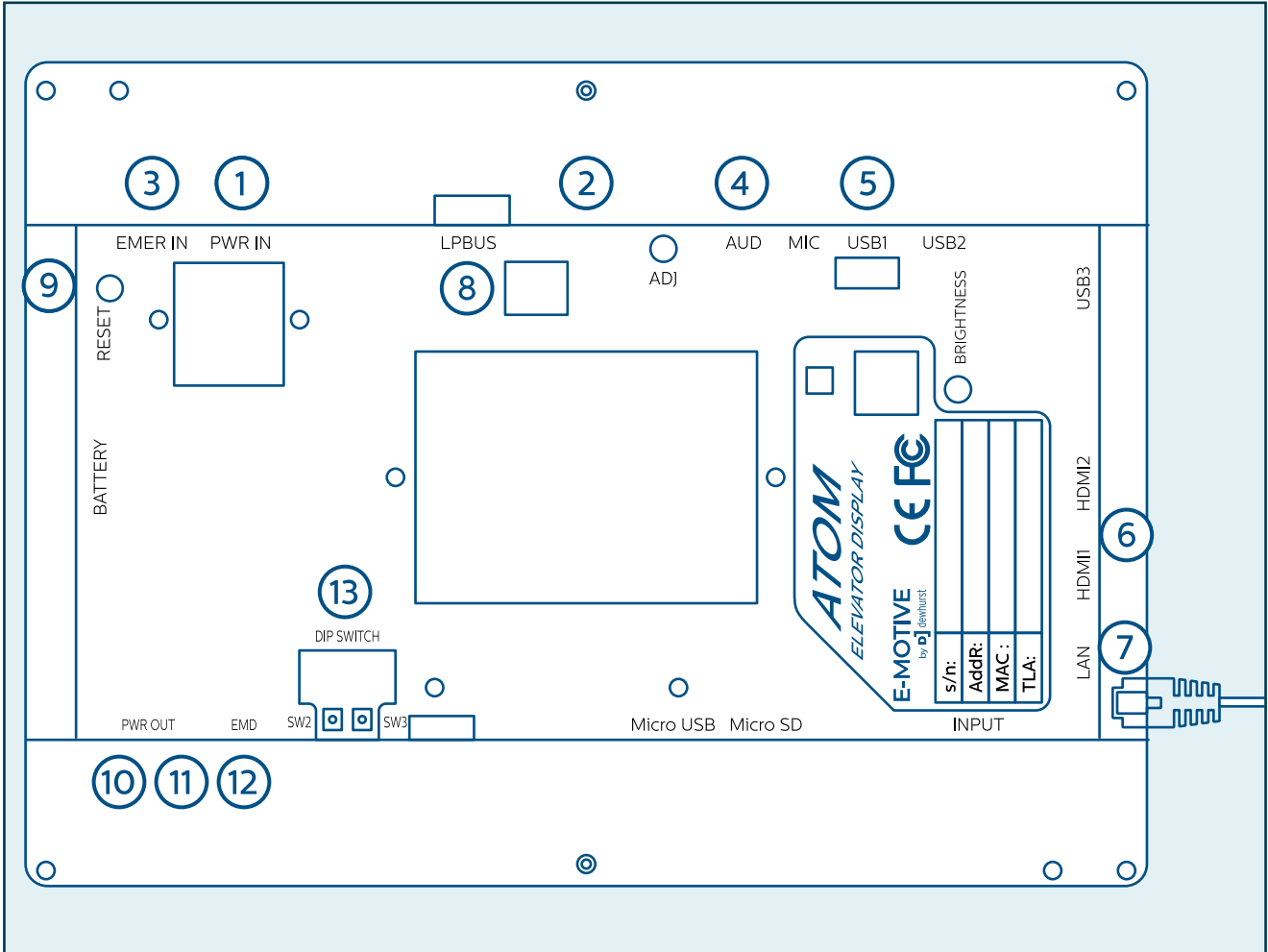

SCREEN SIZE	10.4"	12.1"	15.0"	15.6"	18.5"	21.5"
Model No.	ATOM01-104-7-40-940	ATOM01-121-7-40-940	ATOM01-150-7-40-940	OF-156-914H & ATOM01-000-0-40-900	OF-185-914H & ATOM01-000-0-40-900	OF-215-914H & ATOM01-000-0-40-900

Note:

Emergency power via a UPS or external system can be wired to the display using the EMER IN (3) connection shown above (12V DC). This will allow the display to operate as normal should there be an interruption to the primary power supply. If accessories or slave displays are being powered from the on-board outputs (10/11), then please note these may be effected when the power is switched to the emergency input.

1. Power Input -12V-24V/GND -Power Connector	
Connector Type	KF2EDGR-5.0-2P from KaiFeng or equivalent
Mating Connector Type	KF2EDG-X-5.0-2P from KaiFeng or equivalent
Pin 1	Supply Ground/ Supply (+12V-24V)
Pin 2	Supply Ground/ Supply (+12V-24V)

2. Signal Input/Output - MKCAN In/Out	
Connector Type	MC 1,5/4-G-3,5-1844236 Green from Phoenix Contact or equivalent
Mating Connector Type	MC 1,5/4-ST-3,5-1840382 Green from Phoenix Contact or equivalent
Pin 1 - VCAN	Supply Input
Pin 2 - CANH	CAN H Signal
Pin 3- CANL	CAN L Signal
Pin 4 - GND	Supply Ground
3. Emergency Power Input - EMER IN	
Connector Type	STLZ1550/2G-3.81-V-Green from Phoenix Mecano or equivalent
Mating Connector Type	AKZ1550/2-3.81-Green from Phoenix Mecano or equivalent
Pin 1	Supply +12V
Pin 2	Supply Ground
4. Audio Signal -AUD_R/L -Audio Connector	
Connector Type	STLZ1550/2G-3.81-V-Green from Phoenix Mecano or equivalent
Mating Connector Type	AKZ1550/2-3.81-Green from Phoenix Mecano or equivalent
5. USB1/USB2/USB3 -USB Connector	
Connector Type	USB Type A (USB 2.0)
Mating Connector Type	Compatible USB Type-A Plug
Connector Type	USB-SR-4A from MoreThanall or equivalent
Mating Connector Type	Compatible HDMI Lead
6. HDMI (HDMI1/HDMI2-HDMI Connector)	
Connector Type	47151-1001 from Molex
Mating Connector Type	HDMI Cable
7. LAN1 - LAN Connector	
Connector Type	J0026D21BNL from Pulse or equivalent
Mating Connector Type	RJ45 LAN Connector
8. Network Status LEDs & MKCANBus 2-Way Dipswitch	
9. Power Status LED & Power Reset	
10. Power Output -5V GND -Power Connector	
Connector Type	STLZ1550/2G-3.81-V-Green from Phoenix Mecano or equivalent
Mating Connector Type	AKZ1550/2-3.81-Green from Phoenix Mecano or equivalent
Pin 1 -5V	Supply 5V DC
Pin 2 - GND	Supply Ground
11. Power Output -12V GND -Power Connector	
Connector Type	KF2EDGR-5.0-2P from KaiFeng or equivalent
Mating Connector Type	KF2EDG-X-5.0-2P from KaiFeng or equivalent
Pin 1 -12V	Supply 12V DC
Pin 2 - GND	Supply Ground
12. Input Signal - EMD	
Connector Type	STLZ1550/2G-3.81-V-Green from Phoenix Mecano or equivalent
Mating Connector Type	AKZ1550/2-3.81-Green from Phoenix Mecano or equivalent
Pin 1 - DR	Data Return
Pin 2 - D	Data

Installation guide

2. Mechanical installation

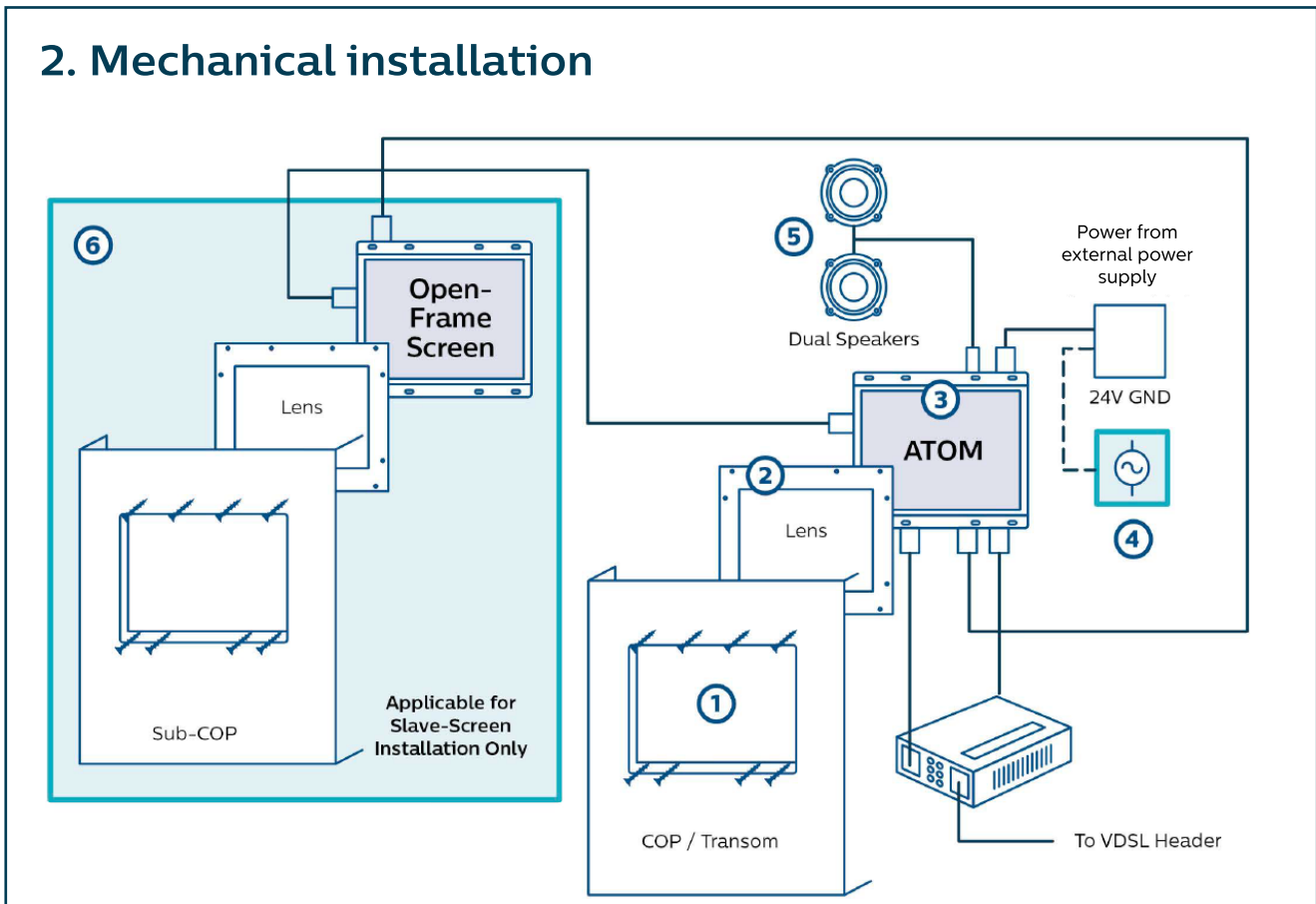

Step by Step Guide

1. Prepare the COP cut-out and mounting studs according to the mechanical drawing of the screen/lens used. Ensure sufficient air space around the LCD unit for ventilation
2. Next, mount the lens. This item is optional. A lens is recommended for the additional protection of the screen and the aesthetic look of the COP/Transom. Peel adhesive first and stick to screen
3. Mount the ATOM LCD unit
4. Prepare 1 x Mains (110/230VAC) socket and connect to PSU 135-0-1-0022. Connect power supply to PWR IN (P1/P2) on the ATOM LCD unit.*
5. Mount the speakers on the car-top, with the speakers facing into the car and connect to ATOM unit using AUD L/R connections.
6. If there is an Open frame application, follow step 1 to 4 for the mounting and use the HDMI & 12VDC outputs on the display to provide HDMI and power to the slave screen.
7. For connected displays, connect the VDSL Tail unit to the display using the LAN connection and ensure VDSL Head/Tail are correctly configured using the dipswitch selection on the VDSL units. The VDSL Tail can be powered by the 12V or 5V output on the display.

*Please adhere to instructions on power supply. If using third party PSU, note that functionality of power outputs (12V/5V) may be effected.

Caution



- + Risk of electric shock. Never remove the casing of the unit
- + Ensure that the power supply is connected properly and that the voltage is correct before turning on the system.
- + Handle LCD unit with care. Do not knock or place heavy object on the top surface of the LCD unit
- + Avoid direct contact with heat dissipating components e.g. heat sink
- + PSU 135-0-1-0022 has selectable AC voltage inputs. Always ensure this is checked before connecting the display
- + Do not operate this product in potentially explosive atmospheres

Network overview - Encoder

Central Location

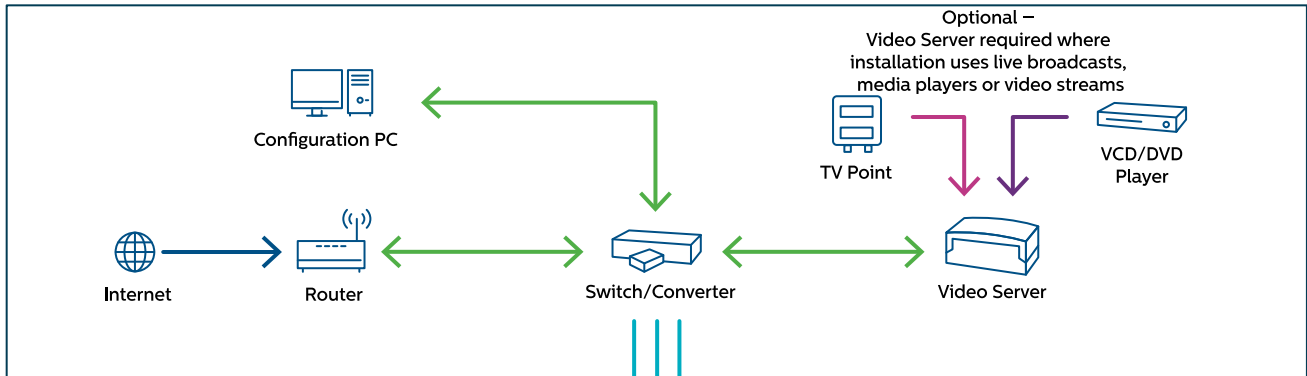

Machine Room 1

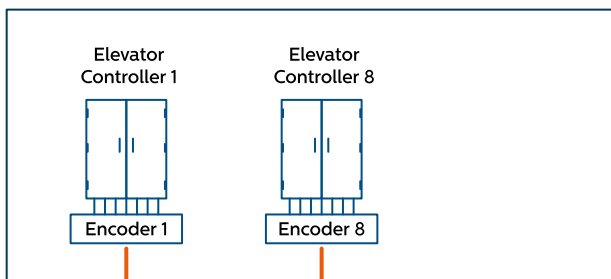

Machine Room 2

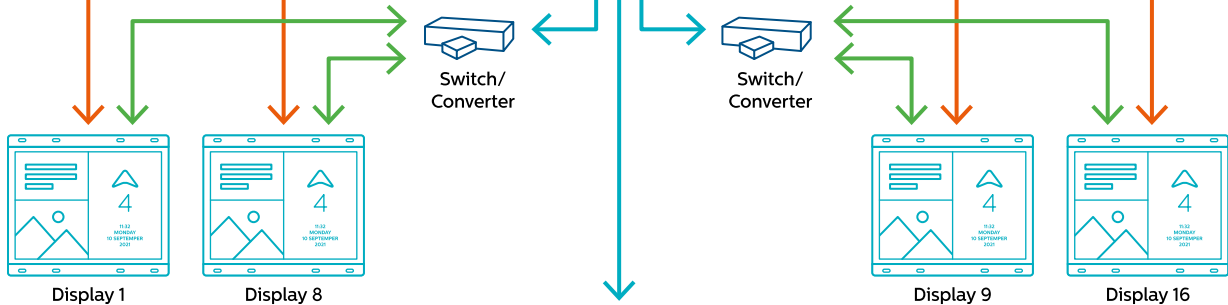
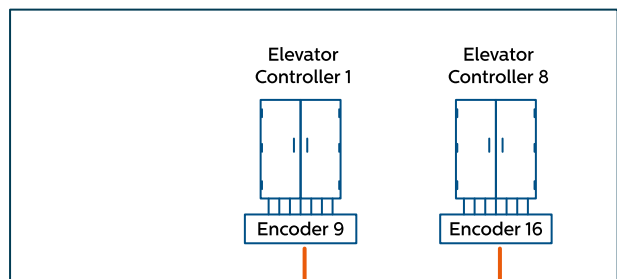

To other Machine Rooms

- 1 x Shielded Twisted Pair Cable (AWG 18 or CSA 0.75mm²), VDSL Solution (up to 1km between network devices)
- Cat 5e/6 LAN Cable, Ethernet Interface (max 90m)
- RCA Cable, S-Video/Composite Video (Audio) Signal
- RG6/11 Coaxial Cable, DVB-T RF Signal
- 2 x PVC Wires (AWG 18 or CSA 0.75mm²), E-Motive 4-Wire Serial Interface
- PVC Wires (AWG 18 or CSA 0.75mm²), Elevator Signal

Network overview - Navigation Box

Central Location

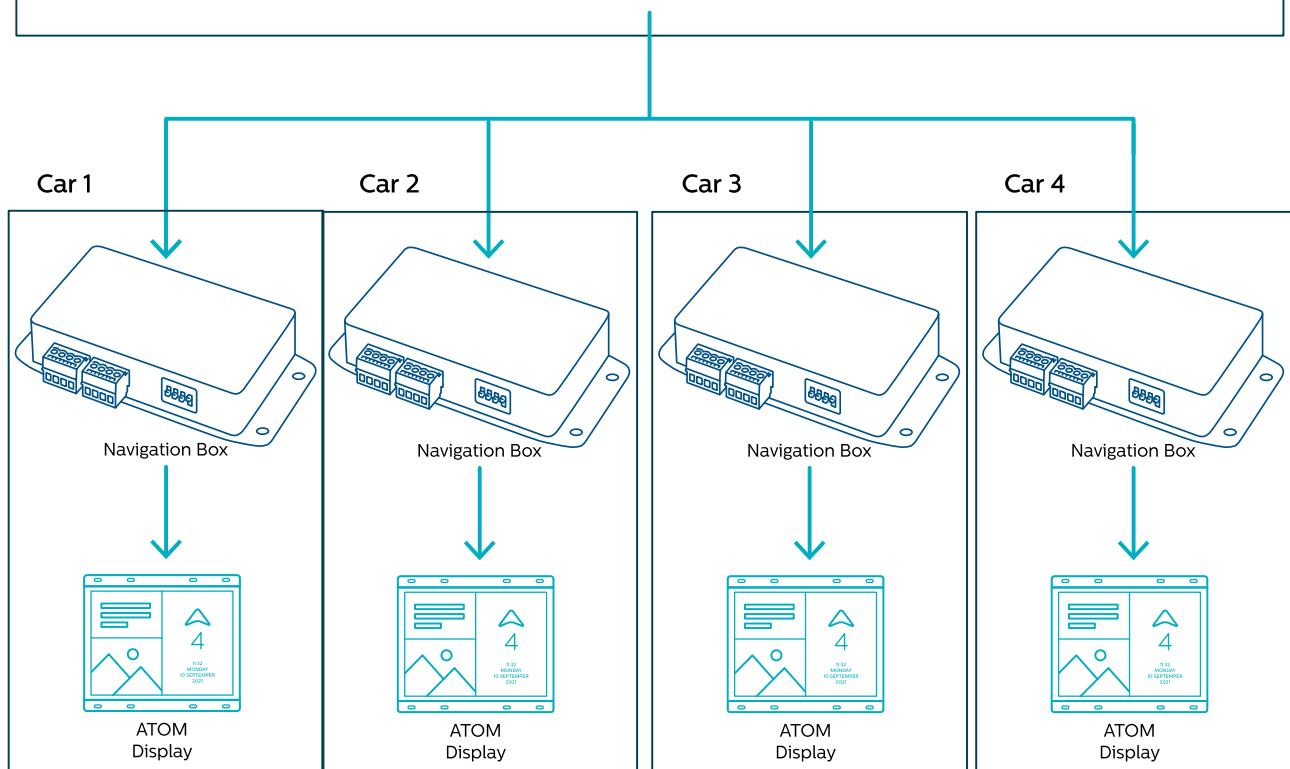
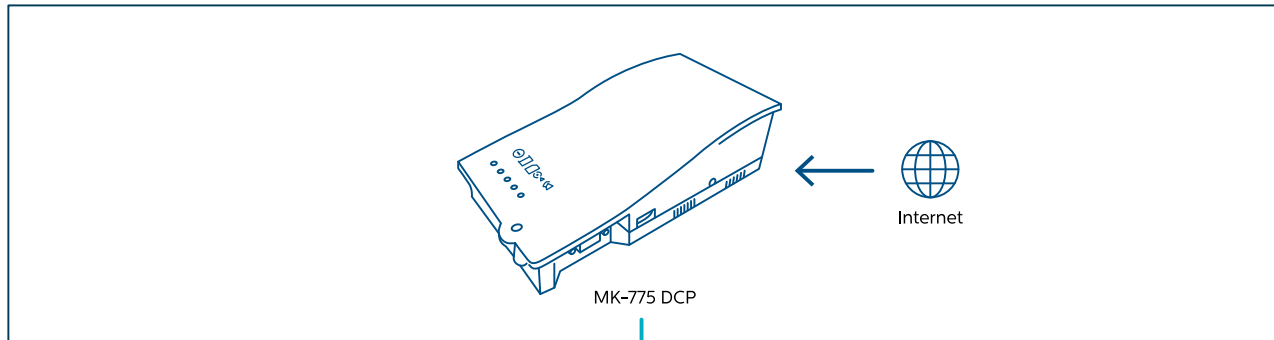

3. Quick Setup

3.1 Setup & Configuration - Lift Controller - Serial (E-Motive 4-Wire)

3.1.1 Encoder/Converter Board Wiring and Setup

To show lift position and status information on the ATOM, an E-Motive encoder is required.

The CX-BASIC standard encoder provides a single serial data connection to the ATOM display via 4-wire connection. Power to the CX-BASIC can be supplied directly from the Display without the need for a separate power supply.

The following shows how to connect the CX-BASIC encoder into the ATOM display.

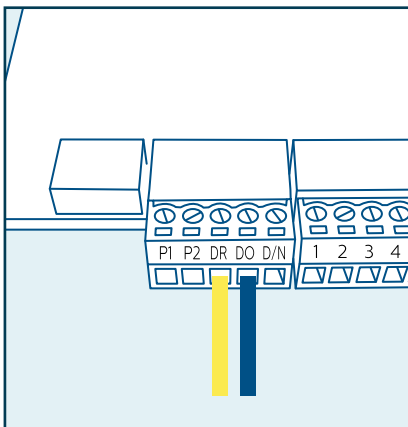

1. Connect data & data return wiring for the 4-wire serial output (JP9 SER1) on the CX-BASIC

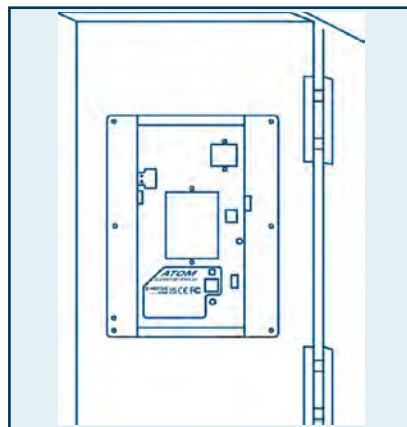

2. Ensure the screen is mounted correctly within the fixture

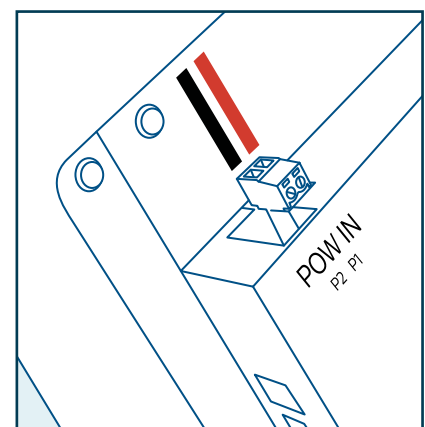

3. Screw in the power and ground wiring to the ATOM Display. The input is 12-24V DC and dual-polarity.

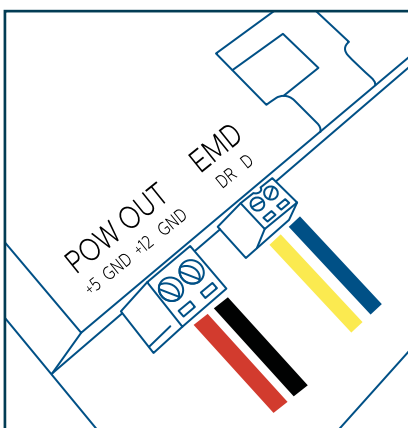

4. Connect data & data return to EMD serial communication on the display from the CX-BASIC (JP9 SER1). Screw in the power wiring for the CX-BASIC from the display 12V DC output, taking care to follow the correct pin arrangement

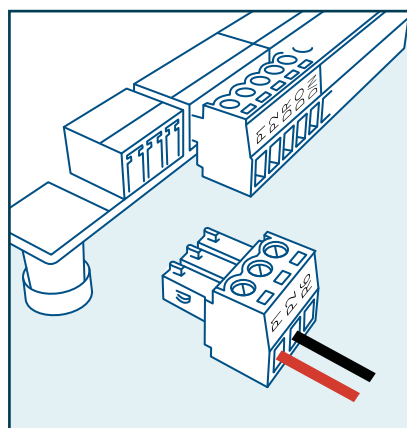

5. Connect power wiring from 12V DC output to P1 & P2 on the CX-BASIC Encoder Board.

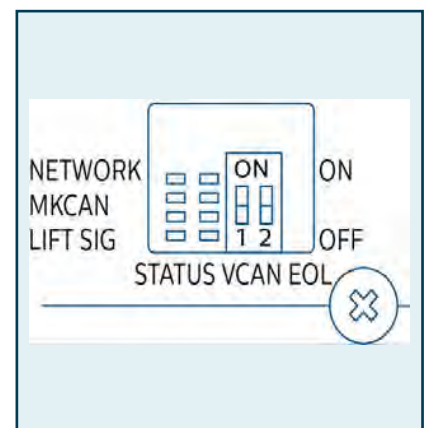

6. Ensure VCAN & EOL Switches are "OFF", and Serial data is set to "E-Motive 4 Wire" in the on-board menu.

Caution



- + Risk of electric shock. Never remove the casing of the unit
- + Ensure that the power supply is connected properly and that the voltage is correct before turning on the unit.

ATTENTION – Electrostatic Discharge (ESD) Safe Handling

1. Remove the display from anti static package only when it is ready to be installed
2. If there is the need to set the display down, put it back into the anti static package itself (do not put the display on a metal surface)
3. Handle the display only by holding it by its frame or edges
4. Do not touch exposed circuitry, pins or joints
5. Limit movement while handling the display as movement can cause static exectricity to build up
6. Additional care needs to be taken while handling the display during cold weather as heating reduces indoor humidity resulting in an increase in static electricity



3.1.2 Example Wiring Architecture

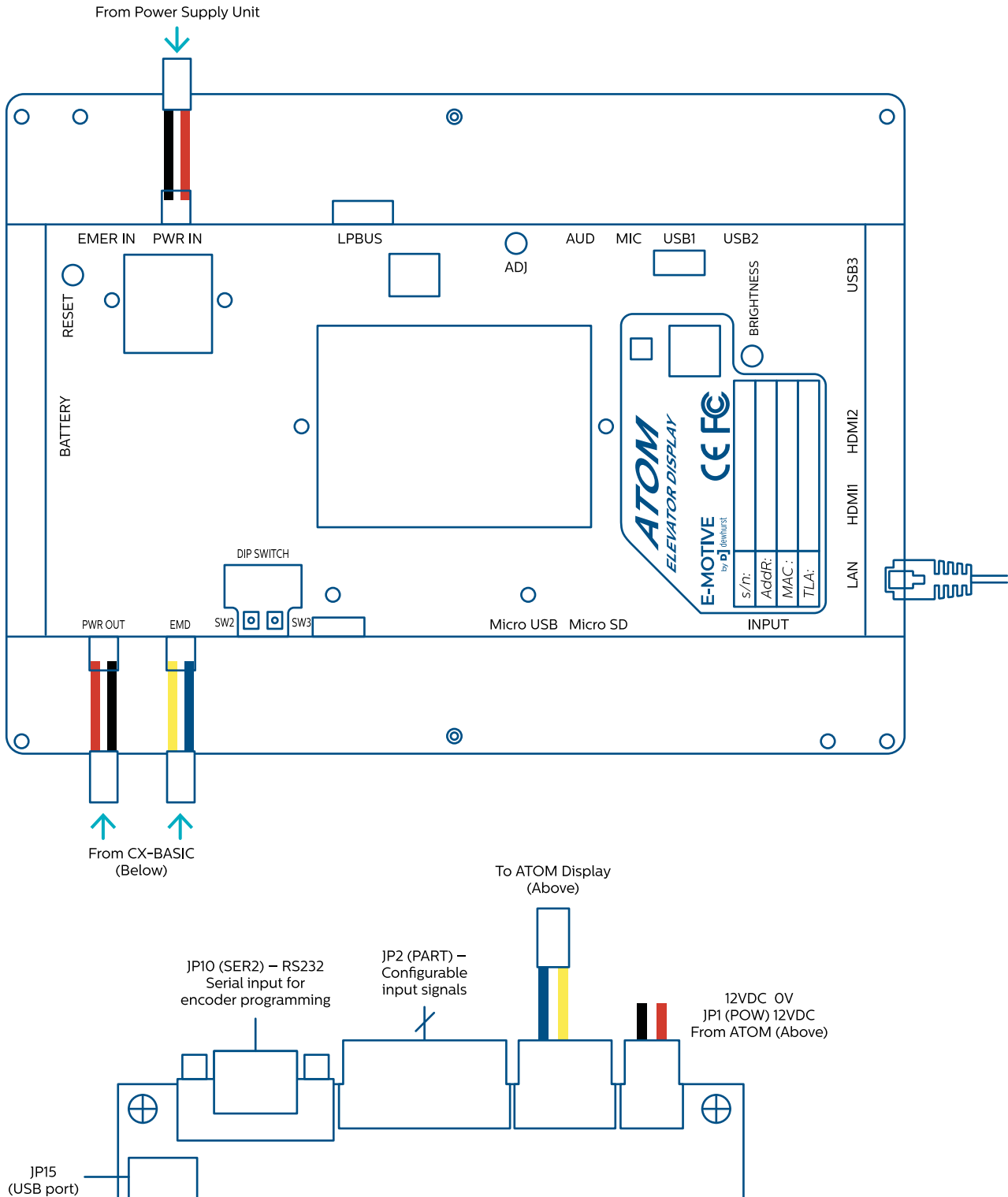

3.2 Setup & Configuration - MKCANBus - Navigation Box

3.2.1 Navigation Box Wiring and Setup

The Navigation Box can be used to accurately measure floor position in elevator shafts up to 12 floors (around 30m total travel). This works by measuring the atmospheric pressure changes at different altitudes, and sending the relevant position through our MKCAN Bus connection directly on the display.

The MKCAN Bus line can then be continued onto other Ecosystem devices to save on wiring, or simply terminated at the Navigation Box/Display.

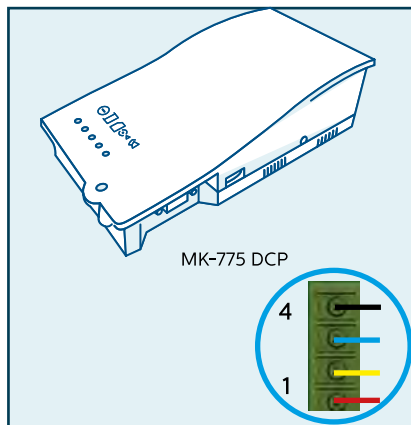

1. Connect V+/CANH/CANL/GND wiring from DCP (J8) to either connection on the Navigation Box. If no DCP is being used, skip to step 2.

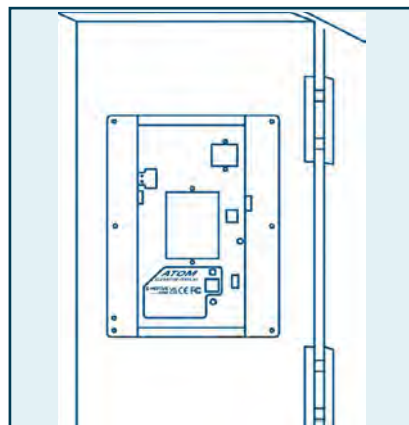

2. Ensure the screen is mounted correctly within the fixture.

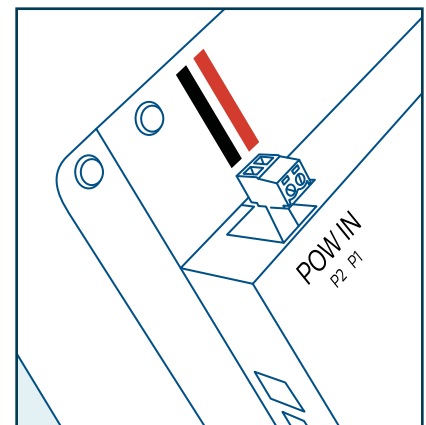

3. Screw in the power and ground wiring to the ATOM Display. The input is 12-24V DC and dual-polarity.

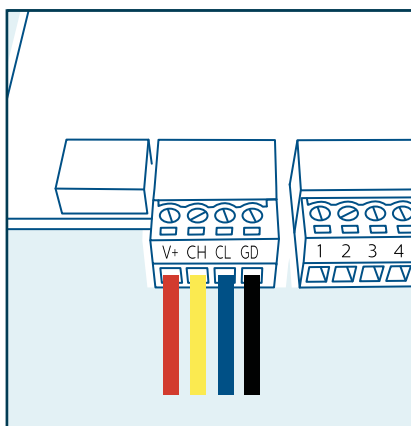

4. Connect VCAN/CANH/CANL/GND wiring to MKCAN OUT on the display, and wire directly to the other input on the Navigation Box. Connect the other Output on the Navigation Box to the MKCAN connection on the DCP (step 1).

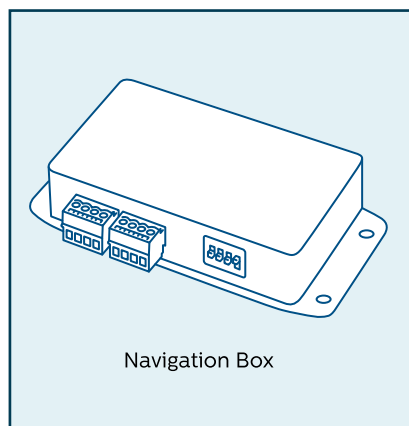

5. Follow Navigation Box installation guide to run "Nav Learn" process. Note: Navigation will not operate correctly until learn process has been completed.

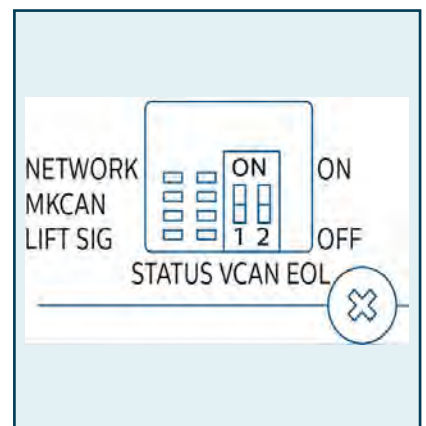

6. Ensure VCAN & EOL are set to "ON" (found on rear of display). Set Serial Input Type to "MKCANBus" in the on-board menu.

7. Set "MKCAN Group ID" & "MKCAN Ext. Addr." in the display on-board menu. MKCAN Group ID is used to designate the MKCAN Group, each of which can contain up to 4 displays with an extended address from 82-85. For example, an installation with 2 elevators, the first with 2 displays the second with only 1, would have the following group ID/extended addresses: "1-82", "1-83", "2-82".

4. Getting Started

4.1 Start-up

Once power is supplied to the ATOM display the E-Motive start-up animation will show and the loaded layout will be presented. The layout can be edited by using the layout designer software and update via USB or LAN connection. The Layout Designer can be accessed using your Hub account credentials on the following URL:

<https://layoutdesigner.avire-global.com/login>

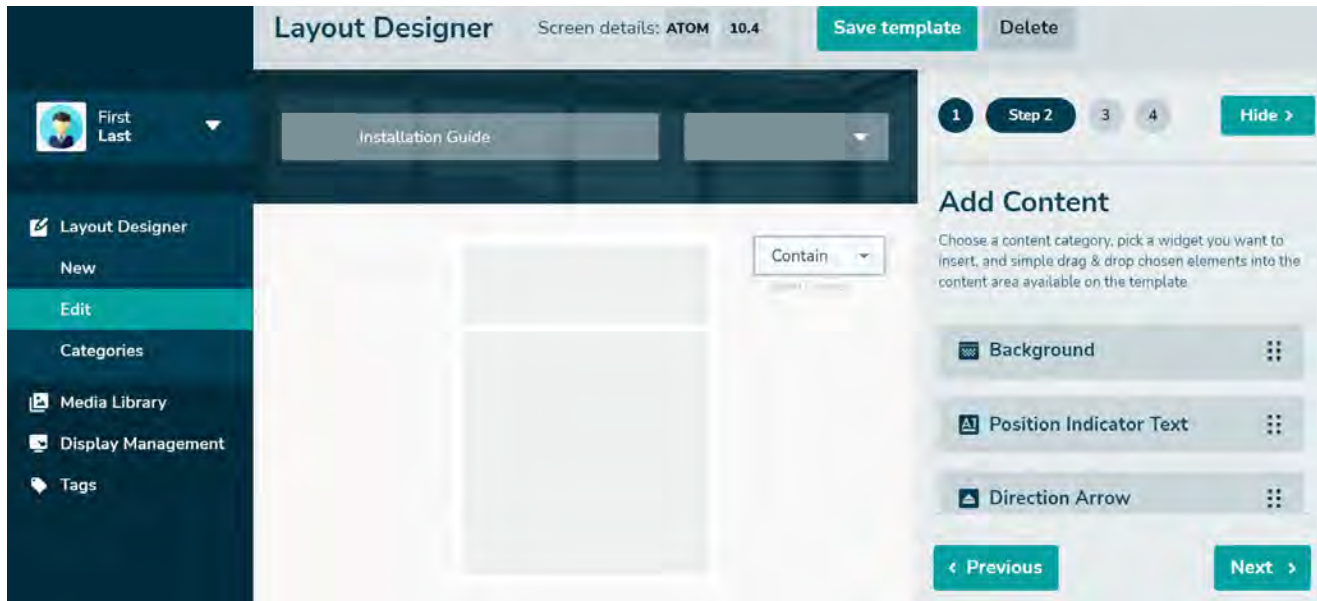

4.2 On-board menu configuration

The ATOM features an on-board programming interface allowing the user to make minor configuration changes such as date, time and time zone configuration. This is configured by a menu that appears when SW2 and SW3 tact switches or pushed together.

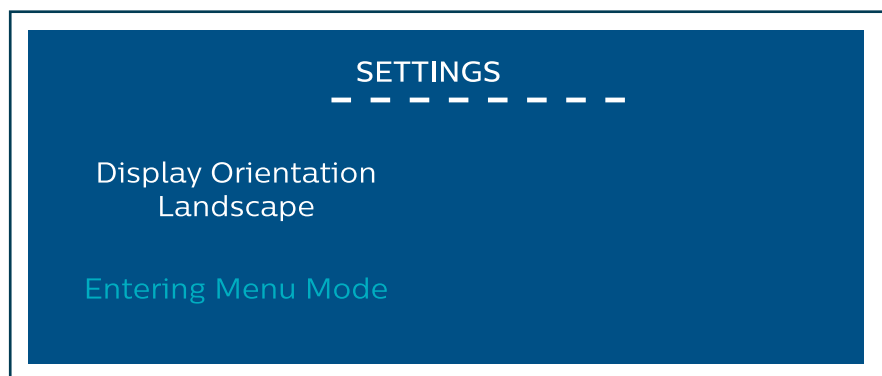
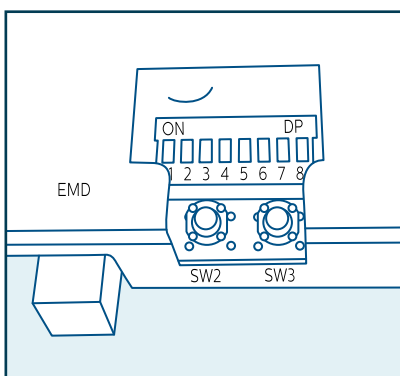

The respective fields can then be set after the “Entering Menu Mode ... “ disappears.

Once the OSD menu is active, you can navigate the menu via tact switch by pressing:

- SW2 for mode select.
- SW3 for item select

5. On-Board Menu Options

Hub Region		
0 - NONE		Set device Hub region for Layout Designer & Device Association Connection.
1 - GLOBAL		
2 - US		
3 - APAC		
4 - CHINA		
Input Type Serial		
E-Motive 4-Wire		Select the display serial interface
MKCAN Bus		
MKCAN Group ID		
1-4		Select MKCAN Group ID for multiple elevator shafts/groups.
MKCAN Ext. Address		
82-85		Select MKCAN Ext. Address for multiple MKCAN devices.
Nav Learn		
Start		Begin Nav Learn process if Nav Box is installed. If no Navigation Box is connected, this section will show "Not Applicable"
Not Applicable		
Navigator Profile		
Automatic		If no Navigation Box is connected, this section will show "Not Applicable" If Navigation Box is connected, select "Automatic" unless exact elevator speed is known.
>75 cm/s		
30 - 75 cm/s		
15 - 30 cm/s		
DST Zone		
0		Set device daylight savings time settings.
1 - US		
2 - UK		
3 - AUS		
4 - NZ		
5 - Custom		
	DST Month+	
	DST Day+	
	DST Week Day+	
	DST Month -	
	DST Day -	
	DST Week Day -	
Date/Time		
Year		Set display date & time settings. Note: If the display has a live internet connection, then the date/time will be automatically set using the regional details set in the Hub building information.
Month		
Day		
Hour		
Minute		
Display		
Car		Set display location
Landing/ Address		Car - Car Operating Panel
	1-128	Landing - Landing Panel - Set Landing Address between 1-128

Technical Specifications

SCREEN SIZE	10.4"	12.1"	15.0"	15.6"	18.5"	21.5"
Model No.	ATOM01-104-7-40-940	ATOM01-121-7-40-940	ATOM01-150-7-40-940	OF-156-914H & ATOM01-000-0-40-900	OF-185-914H & ATOM01-000-0-40-900	OF-215-914H & ATOM01-000-0-40-900

DISPLAY

LCD Display Type	Thin Film Transistor (TFT)					
Colour Depth	True Colour (24-bit colour)					
Resolution	1024 x768	1024 x768	1024 x 768	1920 x1080	1920 x1080	1920 x 1080
Aspect Ratio	4:3	4:3	4:3	16:9	16:9	16:9
Viewing Area (W x H) (mm)	211 x 158	246 x 185	304 x 228	344 x 194	409 x 230	477 x 268
Horizontal Viewing Angle (°)	+88/-88	+88/-88	+85/-85	+89/-89	+89/-89	+89/-89
Vertical Viewing Angle (°)	+88/-88	+88/-88	+85/-85	+89/-89	+89/-89	+89/-89
Luminance	400	500	270	400	350	300
Contrast Ratio	700:1	1200:1	1500:1	800:1	1000:1	5000:1

ELECTRICAL & ENVIRONMENTAL

Operating Voltage (VDC)	12-24V DC					
Typical Current Consumption (A) Main/Aux Display	1.38/0.5	1.54/1	1.71/0.92	0.71/1.42	0.71/1.67	0.71/1.17
Typical Power Consumption (W) Main/Aux Display	16.5/6	18.5/12	20.5/11	8.5/17	8.5/20	8.5/14
Operating Temperature (°C)	0 < 50					
Humidity Range (%RH)	10 < 90					
Backlight MTBF (Hrs)	50,000					

MECHANICAL

Mounting options	Flush Mount						
Overall Dimensions ⁴ (W x H x D mm)	280 x 235 x 38	290 x 240 x 38	357 x 289 x 37.5	202 x 277.5 x 23			
	Main Screen			Central Processing Unit (CPU)			
	280 x 235 x 30	290 x 240 x 30	357 x 289 x 30	398 x 222 x 38	494 x 270 x 40	435 x 380 x 40	527 x 338 x 38
	Auxillary Screen, if required			Auxillary Screen			

COMMUNICATION & I/O INTERFACES

Signal Interface	E-Motive 4-Wire, MKCAN
Network Interface	Ethernet (RJ45)
I/O Interface	DC-In, DC-Out, HDMI, USB, Audio-Out